

Sturlite **X**[®]



Built
to Last

Designed
to Save

PRODUCT MANUAL 2020



Life is all about making choices
That's what we do
All Day. Every Day

We are flooded with images and visuals of everything being Perfect.
The idea of an Ideal Life constantly being sold to us.
But deep down we know, Beauty is found in Imperfections
It is the Original which touches our heart.

In Nature, everything is Imperfectly Perfect.
Trees can be contorted, bent in weird ways & they're still beautiful.
In fact celebrated.

At, Sturlite, that's what we believe in.
Authentic, Real & Soulful

This Catalogue is not just a selection of our signature products.
It is a celebration of Humanity.
A celebration of the Common man in all of it's faces & forms.

We invite you to go ahead and explore our world.



LIGHT

is possibility

EMPOWER



Lighting up Homes, Offices, Industries &
Spaces instilling a sense of Safety, Security &
Intimacy

UNITE



Bringing together spaces in ways which makes them accessible
and changes the way they are Perceived

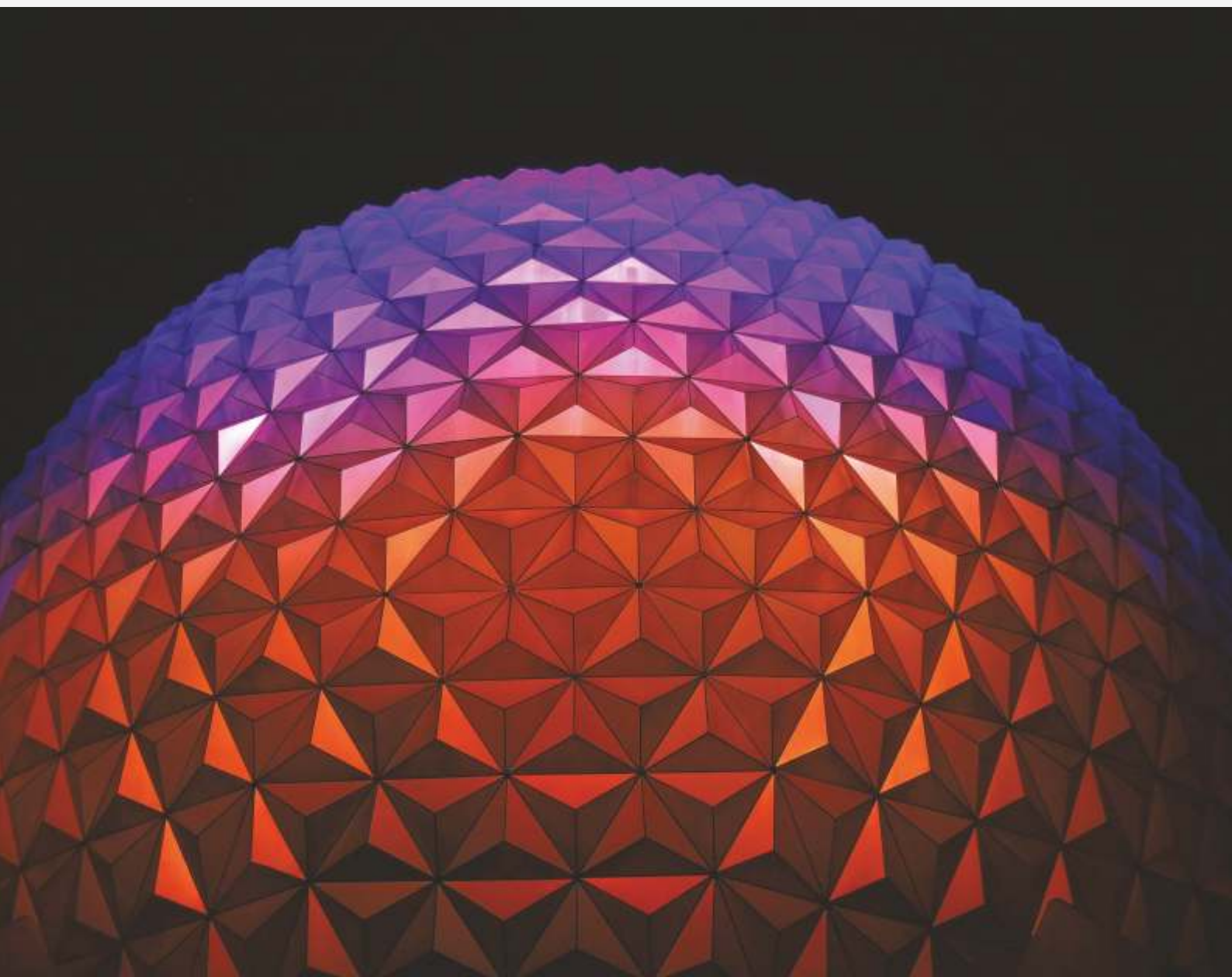



Leveraging Lighting Solutions to alter, convert & modify Spaces in ways which pushes them light years ahead

TRANSFORM



CONTENTS



LED Panel Light
Page 1-14



LED Bulkhead
Page 30-34



LED Strip Light
Page 63-67



LED Surface Light
Page 15-16

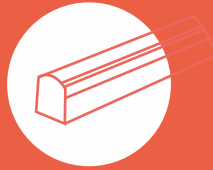

LED Battens & T Bulb
Page 35-42



LED Flood Light
Page 68-73



Square Panel
Page 17-22



LED Track Light
Page 43-48



LED Street Light
Page 74-77



LED Down Light
Page 23-25



LED Spot Light
Page 49-56



LED High-bay Fitting
Page 78-79



LED Mini Fitting
Page 26-29



LED Rope Light
Page 57-62



**Solar Flood Light &
Street Light**
Page 80-83



HYPER X Get More





HYPER X LED PANEL LIGHT

SMD	AC 85-265V	CCT WH/WW/NW	FORM RD/SQ	IP20	 120°	Ra 90	2 YEAR GUARANTEE
-----	---------------	-----------------	---------------	------	--	-------	------------------

CODE	POWER	LUMENS	PF	CUT OUT	DIMENSION	BOX QTY	PRICE
ST131	10W	1100	>0.9	Ø70 or 2.75"	Ø93X37	60	584
ST132	15W	1650	>0.9	Ø95 or 3.75"	Ø120X37	60	777
ST133	22W	2420	>0.9	Ø142 or 5.6"	Ø170X37	40	1225

* All sizes are in mm or inches



True Colour

- 1 Modern, Unobtrusive Design
- 2 Full transparent cover providing homogeneous light effect
- 3 Driver with Inbuilt Protection
- 4 High performance LED's with 110 Lm/W

SAY
BYE-BYE TO
CEILING
DAMAGE

PONG
MODULAR LED DOWNLIGHT



Twist & Fit





Press & Fit



PONG MODULAR LED DOWNLIGHT

SMD
AC 85-265V
CCT WH
FORM RD/SQ
IP20
Ra 90
120°
2 YEAR GUARANTEE

CODE	POWER	LUMENS	PF	CUT OUT	DIMENSION	BOX QTY	PRICE
ST351	8W	800	>0.9	Ø108 or 4"	Ø122x43.5mm	20	540
ST352	15W	1500	>0.9	Ø158 or 6"	Ø172x43.5mm	20	831
ST353	22W	2200	>0.9	Ø196 or 8"	Ø210x43.5mm	20	1074

* All sizes are in mm or inches

- 1 Ease Of Replacement Without Damaging the False Ceiling
- 2 Flexibility Of Changing Ambience With Same Housing
- 3 Industry Best Lighting At 100Lm/W
- 4 High Color Rendering With CRI>90



TIC TAC
More Lighting, More Versatile

DESIGNED TO **ADJUST**
ANYWHERE

ADJUSTABLE
CLIPS



TIC TAC LED PANEL LIGHT

SMD
AC 85-265V
CCT WH/WW
FORM RD/SQ
IP20
120°
Ra 90
2 YEAR GUARANTEE

CODE	POWER	LUMENS	PF	CUT OUT	DIMENSION	BOX QTY	PRICE
ST861	12W	1320	>0.9	Ø75-100 or 3"-4"	Ø120 x 30	40	739
ST862	18W	1980	>0.9	Ø75-150 or 3"-6"	Ø170 x 32	20	1171
ST863	24W	2640	>0.9	Ø75-200 or 3"-8"	Ø223 x 32	20	1585



* All sizes are in mm or inches

- 1 Adjustable Clips For Various False Ceiling Size
- 2 Full Transparent Cover Providing Homogeneous Light Effect
- 3 Build To Resist Yellowing & Chipping
- 4 High Performance LED'S with 110 Lm/W



DEX

Simply Great Light





DEX RECESS-BACKLIT LED PANEL LIGHT

SMD	AC 85-265V	CCT/NW WH/WW	FORM RD/SQ	IP20	120°	Ra 90	2 YEAR GUARANTEE
-----	---------------	-----------------	---------------	------	------	-------	------------------

CODE	POWER	LUMENS	PF	CUT OUT	DIMENSION	BOX QTY	PRICE
ST190	8W	880	>0.9	Ø110 or 4"	Ø116 X 116 X 35	40	375
ST191	15W	1650	>0.9	Ø160 or 6"	Ø166 X 166 X 35	40	508
ST192	22W	2420	>0.9	Ø210 or 8"	Ø218 X 218 X 35	20	800

* All sizes are in mm or inches

- 1 High Performance LED's With 110 Lm/W
- 2 High Quality Polycarbonate And Die Cast Aluminium
- 3 Wide Voltage Range And Surge Protection
- 4 Good Color Quality With CRI>90

Create A Relaxing Environment

Sturlite Panel light offers a warm, soft white light perfect for comfortable moments & cozy spaces. Use our panel lights in spaces like bedrooms, family rooms & dining rooms.

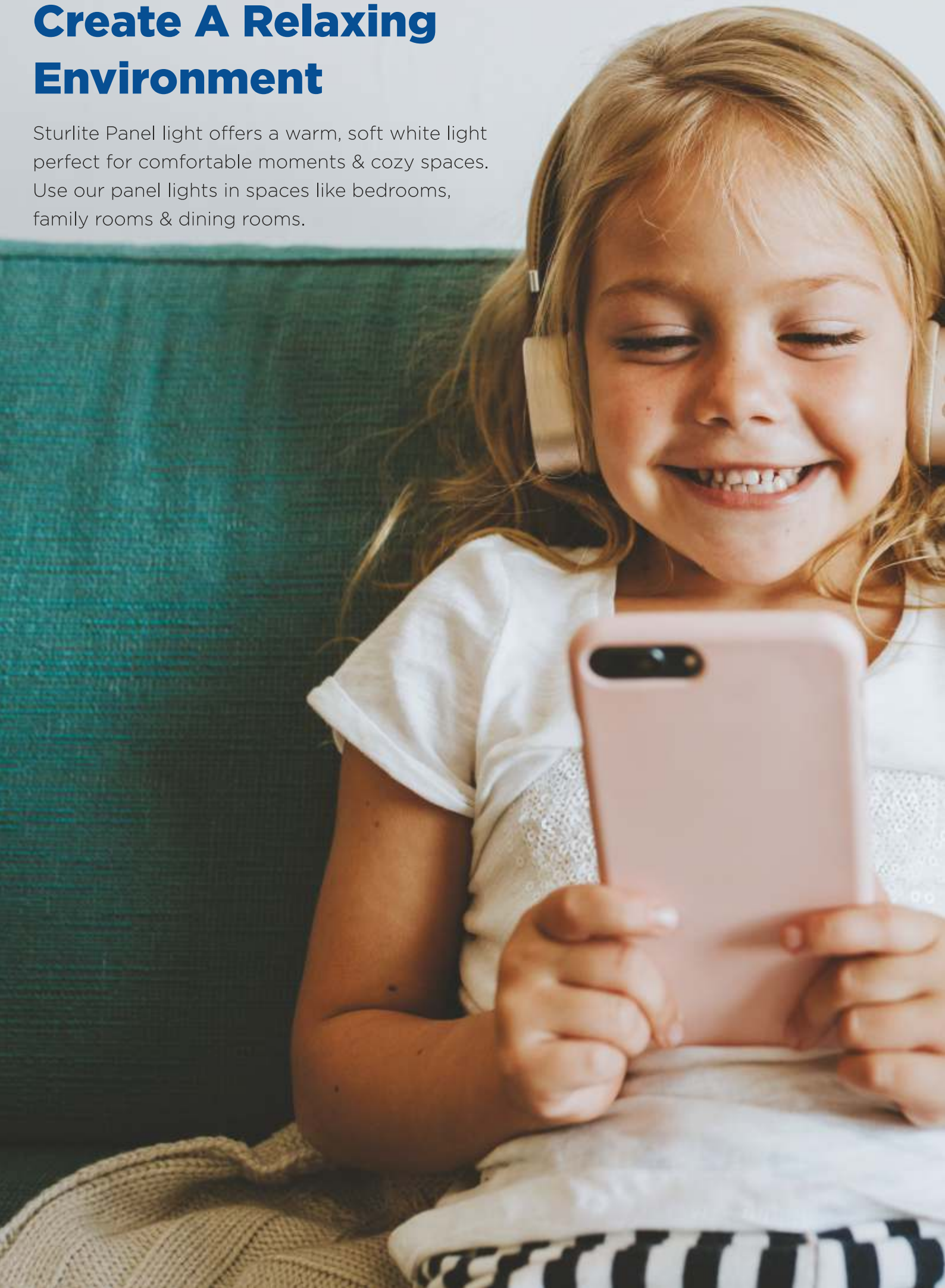

BENEFITS

Beautiful soft, balanced
light without the glare

High Color
Quality

Reduced Maintenance
Cycles





EVOC

Best In Class Performance Standard



EVOC LED PANEL LIGHT

SMD
AC 85-265V
CCT WH/NW/WW
FORM RD/SQ
IP20
120°
Ra 85
2 YEAR GUARANTEE

CODE	POWER	LUMENS	PF	CUT OUT	DIMENSION	BOX QTY	PRICE
ST110	3W	255	>0.5	Ø75 or 3"	Ø90X40	60	307
ST111	6W	510	>0.5	Ø100 or 4"	Ø118X40	60	447
ST112	10W	850	>0.9	Ø125 or 5"	Ø142X40	60	559
ST113	15W	1275	>0.9	Ø150 or 6"	Ø168X40	40	702
ST114	20W	1700	>0.9	Ø198 or 8"	Ø220X40	40	1067

* All sizes are in mm or inches

- 1 High Grade Pc- Aluminium Housing
- 2 Brightest Edge Lit Panel With Efficacy Up To 100 Lm/W
- 3 Driver With Inbuilt Protection
- 4 Good Color Quality With CRI>85

ECO LYF

Minimalistic & Efficient

Sturlite **XX**

ECO LYF LED PANEL LIGHT

SMD	AC 85-265V	CCT/NW WH/WW	FORM RD/SQ	 120°	Ra 80	IP20	2 YEAR GUARANTEE
-----	---------------	-----------------	---------------	--	-------	------	------------------

CODE	POWER	LUMENS	PF	CUT OUT	DIMENSION	BOX QTY	PRICE
ST101	4W	320	>0.5	Ø75 or 3"	Ø85X20	60	232
ST103	8W	640	>0.5	Ø100 or 4"	Ø120X20	40	364
ST104	12W	960	>0.9	Ø126 or 5"	Ø146X20	40	526
ST105	15W	1200	>0.9	Ø150 or 6"	Ø174X20	40	559
ST106	22W	1760	>0.9	Ø205 or 8"	Ø225X20	20	833
ST107	30W	2400	>0.9	Ø280 or 11"	Ø300X40	20	1540

All sizes are in mm or inches

- 1 High Quality Aviation Grade Aluminium
- 2 High performance LED's with 80 Lm/w
- 3 2.5KV Surge Protection
- 4 Anti light leak design



IKON

More Brightness. More Saving.

IKON LED PANEL LIGHT

SMD	AC 85-265V	CCT WH/WW	FORM RD/SQ	IP20	120°	Ra 80	2 YEAR GUARANTEE
-----	------------	-----------	------------	------	------	-------	------------------

CODE	POWER	LUMENS	PF	CUT OUT	DIMENSION	BOX QTY	PRICE
ST181	8W	640	>0.9	Ø100 or 4"	Ø120X20	40	334
ST182	15W	1200	>0.9	Ø150 or 6"	Ø174X20	40	539
ST183	22W	1760	>0.9	Ø205 or 8"	Ø225X20	20	847

All sizes are in mm or inches

- 1 Driver With Inbuilt Protection
- 2 Full Transparent Cover Providing Homogeneous Light Effect
- 3 25,000 Burning Hours
- 4 Wide Voltage And Surge Protection



S-FIT

The Shape You Know
With The Performance You Need



S-FIT LED SURFACE LIGHT

SMD	AC 85-265V	CCT/NW WH/WW	FORM RD/SQ	IP20	120°	Ra 80	2 YEAR GUARANTEE
------------	-----------------------	-------------------------	-----------------------	-------------	-------------	--------------	-------------------------

CODE	POWER	LUMENS	PF	DIMENSION	BOX QTY	PRICE
ST170	8W	776	>0.9	Ø95X95X23	40	558
ST171	12W	1164	>0.9	Ø120X120X23	40	606
ST172	15W	1455	>0.9	Ø145X145X23	20	825
ST173	22W	2134	>0.9	Ø170X170X23	20	1090
ST174	30W	2910	>0.9	Ø220X220X23	20	1733

All sizes are in mm or inches

- 1 High Grade Pc Outer & Aluminium Heat Sink Back
- 2 High Performance LED'S With 100 Lm/W
- 3 Driver With Inbuilt Protection
- 4 2.5Kv Surge Protection

S-TWIST

Twist for a Bright & Efficient Lighting Experience



S-TWIST LED SURFACE LIGHT

SMD	AC 85-265V	CCT WH/WW	FORM RD	IP20	120°	Ra 80	2 YEAR GUARANTEE
------------	-------------------	------------------	----------------	-------------	-------------	--------------	-------------------------

CODE	POWER	LUMENS	PF	DIMENSION	BOX QTY	PRICE
ST145	7W	679	>0.9	Ø85X45	40	610
ST146	9W	873	>0.9	Ø110X45	40	824
ST147	15W	1455	>0.9	Ø170X45	20	1133
ST148	20W	1940	>0.9	Ø185 x 45	20	1847

*All sizes are in mm or inches

- 1 Replacement For Angle Batten Technology
- 2 High performance LED's with 100 Lm/w
- 3 Driver With Inbuilt Protection
- 4 Surge And Inrush Current Protected Driver

REGAL

Best in Class Visual Comfort



REGAL SQUARE 2X2 BACKLIT LED PANEL

SMD	AC 85-265V	CCT WH/WW	FORM SQ	IP20	 120°	Ra 80	2 YEAR GUARANTEE
-----	---------------	--------------	------------	------	--	-------	------------------

CODE	POWER	LUMENS	PF	DIMENSION	BOX QTY	PRICE
ST135	48W	4800	>0.9	Ø595X595	5	2782

*All sizes are in mm or inches

- 1 Higher Light Transmission Rate
- 2 Low Indirect Glare
- 3 High Color Rendering With CRI>80
- 4 Efficacy Of >100 Lm/W Ensures Maximum Savings

REGAL

Efficient Lighting. More Savings

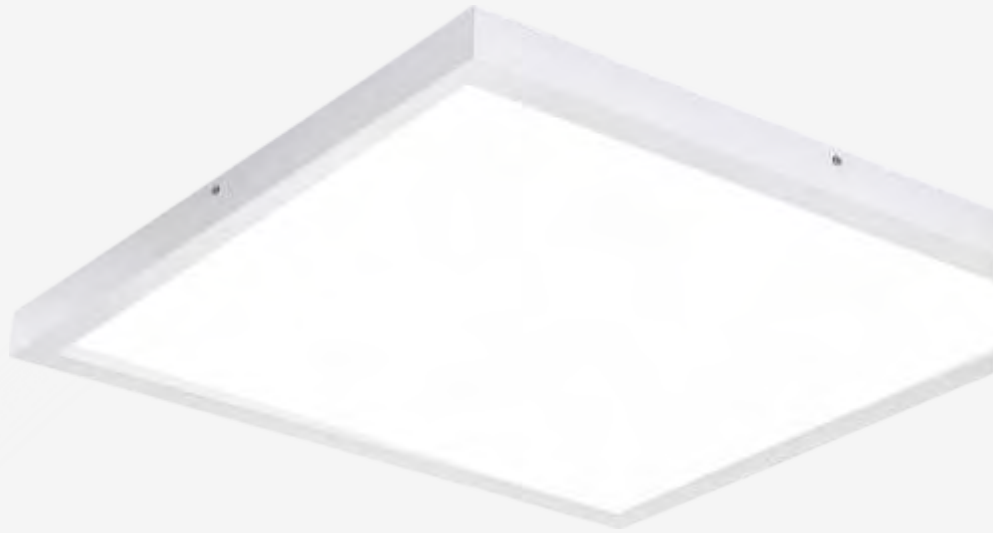

REGAL SQUARE 2X2 SURFACE BACKLIT LED PANEL

SMD	AC 85-265V	CCT WH/NW/WW	FORM SQ	IP20	 120°	Ra 80	2 YEAR GUARANTEE
-----	---------------	-----------------	------------	------	--	-------	------------------

CODE	POWER	LUMENS	PF	DIMENSION	BOX QTY	PRICE
ST125	48W	4800	>0.9	Ø595X595	5	5816

*All sizes are in mm or inches

- 1 Higher Light Transmission Rate
- 2 Low Indirect Glare
- 3 High Color Rendering With CRI>80
- 4 Efficacy Of >100 Lm/W Ensures Maximum Savings

ACER

Vesatile LED Lighting System

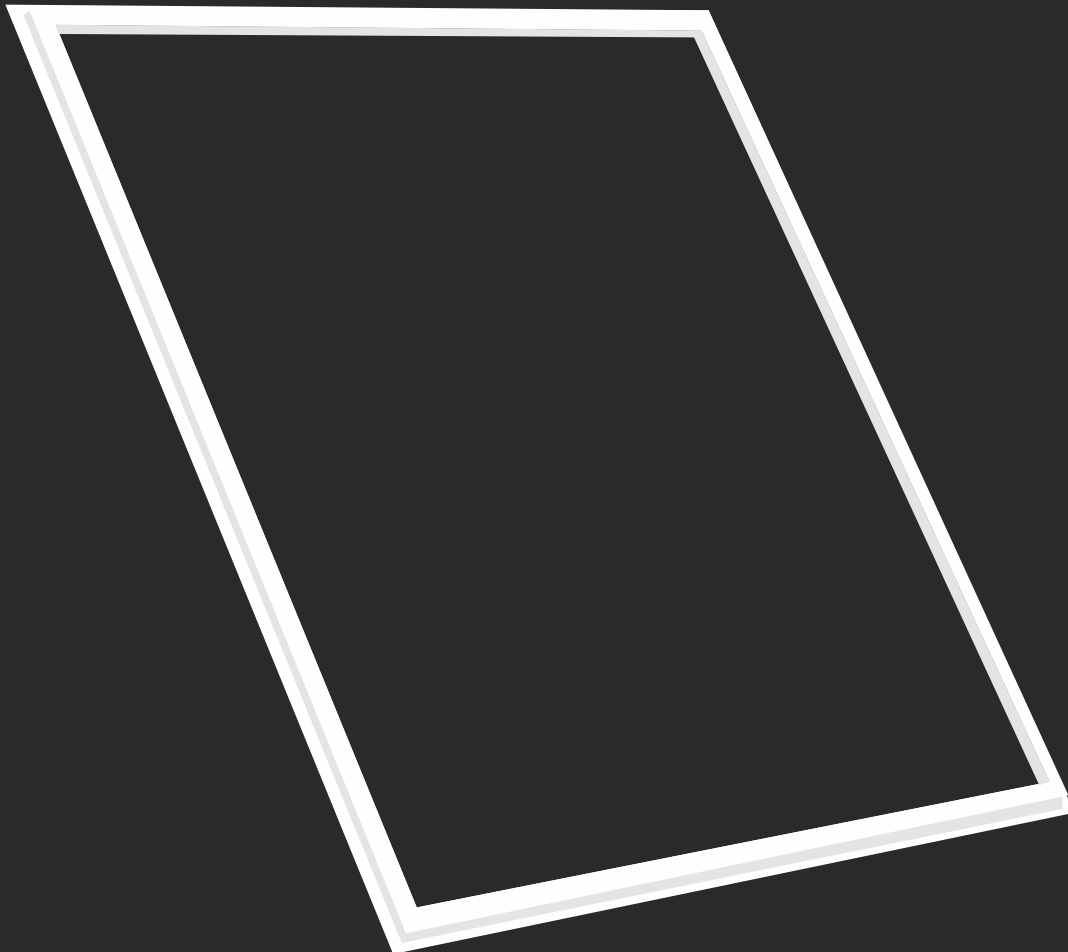

ACER SQUARE 2X2 SURFACE BACKLIT LED PANEL

SMD	AC 85-265V	CCT WH	FORM SQ	IP20	 120°	Ra 75	2 YEAR GUARANTEE
-----	---------------	-----------	------------	------	--	-------	------------------

CODE	POWER	LUMENS	PF	DIMENSION	BOX QTY	PRICE
ST124	48W	4800	>0.9	Ø595X595	5	3423

*All sizes are in mm or inches

- 1 Suitable For Grid Ceiling
- 2 Comfortable Glare Free Light
- 3 Sleek And Seamless Profile Adds To Overall Visual Appearance
- 4 High Luminous Efficiency At 100 Lm/W

ECO LYF

Lighting with a Zest



ECO LYF 1 X 1 SURFACE PANEL



CODE	POWER	LUMENS	PF	DIMENSION	BOX QTY	PRICE
ST108	30W	2400	>0.9	Ø300 x 300	5	2018

*All sizes are in mm or inches

- 1 Higher Light Transmission Rate
- 2 Ultra Slim Design
- 3 3KV Surge Protection
- 4 80 Lm/W

The Clear Choice of Workspace



The new Sturlite Regal Panel range of LED products can be used to replace functional luminaires in general lighting applications. The process of selecting, installing and maintaining is so easy – it's a simple switch.



BENEFITS

Best in Class
Lighting

Significant reduction
in payback Cost

Intergrated LED
Technology

Sustainable
Performance



LEAF

Energy Smart Downlights





LEAF LED DOWNLIGHT

SMD	AC 85-265V	CCT/NW WH/WW/RD/ BL/GN/PK	FORM RD	IP20	120°	Ra 80	2 YEAR GUARANTEE
-----	---------------	---------------------------------	------------	------	------	-------	------------------

CODE	POWER	LUMENS	PF	CUT OUT	DIMENSION	BOX QTY	PRICE
ST245	3W	270	>0.9	Ø50 or 2"	Ø75 X 35	100	130
ST241	6W	679	>0.9	Ø73 or 2.9"	Ø110 X 35	100	238

*All sizes are in mm or inches

- 1 Compact Polycarbonate Housing
- 2 High Performance LED'S With 100 Lm/W
- 3 2.5 Kv Surge And Inrush Protection
- 4 Driver With Inbuilt Protection

TWILITE

Turn on your moments



TWILITE 2 IN 1 LED DOWNLIGHT

SMD	COB	AC 85-265V	FORM RD	IP20	30° + 120°	Ra 80	2 YEAR GUARANTEE
-----	-----	---------------	------------	------	------------	-------	------------------

CODE	POWER	LUMENS	PF	CUT OUT	BOX QTY	PRICE
ST247	7W + 3W	7W 630LM 3W 270LM	>0.9	Ø110X35	100	695

*All sizes are in mm or inches

	White + Warm white		White + Blue
	Blue + White		Green + White
	Blue + Warm White		Warm white + White
	Green + Warm White		Pink + White

- 1 Change The Look, Instantly At The Click Of A Button
- 2 High Performance LED'S With 100 Lm/W
- 3 2.5 Kv Surge And Inrush Protection
- 4 Driver With Inbuilt Protection

TRINKETS

Elements That Invite And Impress



3W DOWNLIGHT PANEL

SMD	AC 85-265V	CCT/NW WH/WW/RD/ BL/GN/PK	FORM RD	IP20		Ra 75	1 YEAR GUARANTEE
------------	----------------------	--	-------------------	-------------	--	--------------	-------------------------

CODE	POWER	LUMENS	PF	CUT OUT	DIMENSION	BOX QTY.	PRICE
ST245	3W	270	>0.9	Ø45 or 1.77"	Ø70x35	100	130

*All sizes are in mm or inches



3W DOWNLIGHT COB

COB	AC 85-265V	CCT WH/WW/RD/ BL/GN/PK	FORM RD	IP20		Ra 75	1 YEAR GUARANTEE
------------	----------------------	-------------------------------------	-------------------	-------------	--	--------------	-------------------------

CODE	POWER	LUMENS	PF	CUT OUT	DIMENSION	BOX QTY.	PRICE
ST251	3W	270	>0.9	Ø52 or 2.05"	Ø70x35	100	274

*All sizes are in mm or inches



3W SPOTLIGHT

COB	AC 85-265V	CCT/NW WH/WW/RD BL/GN//PK	FORM RD	IP20	 35°	Ra 75	1 YEAR GUARANTEE
------------	----------------------	--	-------------------	-------------	---	--------------	-------------------------

CODE	POWER	LUMENS	PF	CUT OUT	DIMENSION	BOX QTY.	PRICE
ST267	3W	270	>0.6	Ø30 or 1.18"	Ø40x30	200	200

* All sizes are in mm or inches



3W SURFACE PANEL

SMD	AC 85-265V	CCT/AMBER WH/WW/RD BL/GN//PK	FORM RD	IP20	 120°	Ra 75	1 YEAR GUARANTEE
------------	----------------------	---	-------------------	-------------	--	--------------	-------------------------

CODE	POWER	LUMENS	PF	CUT OUT	DIMENSION	BOX QTY.	PRICE
ST151	3W	240	>0.6	-	Ø75x30	100	162

*All sizes are in mm or inches



3W DOWN LIGHT COB

COB	AC 85-270V	CCT WH/WW/RD/ BL/GN/PK	FORM RD	Ra 80	IP20	2 YEAR GUARANTEE
------------	-----------------------	---------------------------------------	--------------------	--------------	-------------	-------------------------

CODE	POWER	LUMENS	PF	BEAM	CUT OUT	DIMENSION	BOX QTY.	PRICE
ST621	3W	270	>0.6	35°	Ø67 or 1.8"	Ø67 X 45 X 32	100	242

* All sizes are in mm or inches



1W DOWN LIGHT COB

COB	AC 85-265V	CCT/NW WH/WW/RD/ BL/GN/PK	FORM RD	IP20	 35°	Ra 75	1 YEAR GUARANTEE
------------	-----------------------	--	--------------------	-------------	--	--------------	-------------------------

CODE	POWER	LUMENS	PF	CUT OUT	DIMENSION	BOX QTY.	PRICE
ST261	1W	90	>0.6	Ø25 or 1"	Ø33x25	200	162

* All sizes are in mm or inches

REX

THE PERFECT LIGHT FOR EVERY ROOM



REX 3W DOWN LIGHT PANEL

SMD	AC 85-265V	CCT WH/WW/RD/ BL/GN/PK	FORM RD	IP20	 120°	Ra 75	1 YEAR GUARANTEE
-----	---------------	------------------------------	------------	------	--	-------	------------------

CODE	POWER	LUMENS	PF	CUT OUT	BOX QTY.	PRICE
ST201	3W	270	>0.9	Ø48 or 1.9"	100	138

*All sizes are in mm or inches

VIVA

STYLISH LIGHTING FOR A STYLISH HOME



VIVA WALL LIGHT BULKHEAD

SMD	AC 85-270V	CCT WH/WW	FORM SQ	IP65	 120°	Ra 75	2 YEAR GUARANTEE
-----	---------------	--------------	------------	------	--	-------	------------------

CODE	POWER	LUMENS	PF	DIMENSION	BOX QTY.	PRICE
ST188	20W	1800	>0.9	212 X 98 X 60mm	20	513

*All sizes are in mm or inches

- 1 Bright, Soft Uniform Light
- 2 High Voltage Protection till 380V
- 3 2.5Kv Surge Protection
- 4 Water Resistant Body
- 5 Versatile Solution-Can be Wall mounted on Ceiling & Wall

AVA

Versatile Lighting Solution



AVA LED WALL LIGHT/ DOME LIGHT/ BULKHEAD

SMD
AC 85-265V
CCT WH/WW
FORM SQ
120°
Ra 75
IP65
2 YEAR GUARANTEE

CODE	POWER	FORM	LUMENS	PF	DIMENSION	BOX QTY	PRICE
ST185	12W	SQ	1080	>0.9	Ø220X101X60	20	776
ST186	15W	RD	1350	>0.9	Ø178X58.5X60	20	972

*All sizes are in mm or inches

- 1 Bright, Soft & Uniform Light.
- 2 High Voltage Protection Till 380V
- 3 IP65 Protection & IK08 Impact Resistance
- 4 Long lifetime of 25,000 hours (70% lumen maintenance)
- 5 Versatile Solution- Can Be Mounted On Ceiling & Wall

Reliable landscape lighting for Harmonious City Living

Combining a simple design with reliable lighting performance, this low-cost, high-quality white-light LED wall fixture delivers a soft light effect with attractive uniformity.

BENEFITS

- Bright, Soft & Uniform Light
- Compact, Simple Design
- 20,000 Hrs Long Life
- IP65: Dust & Waterproof

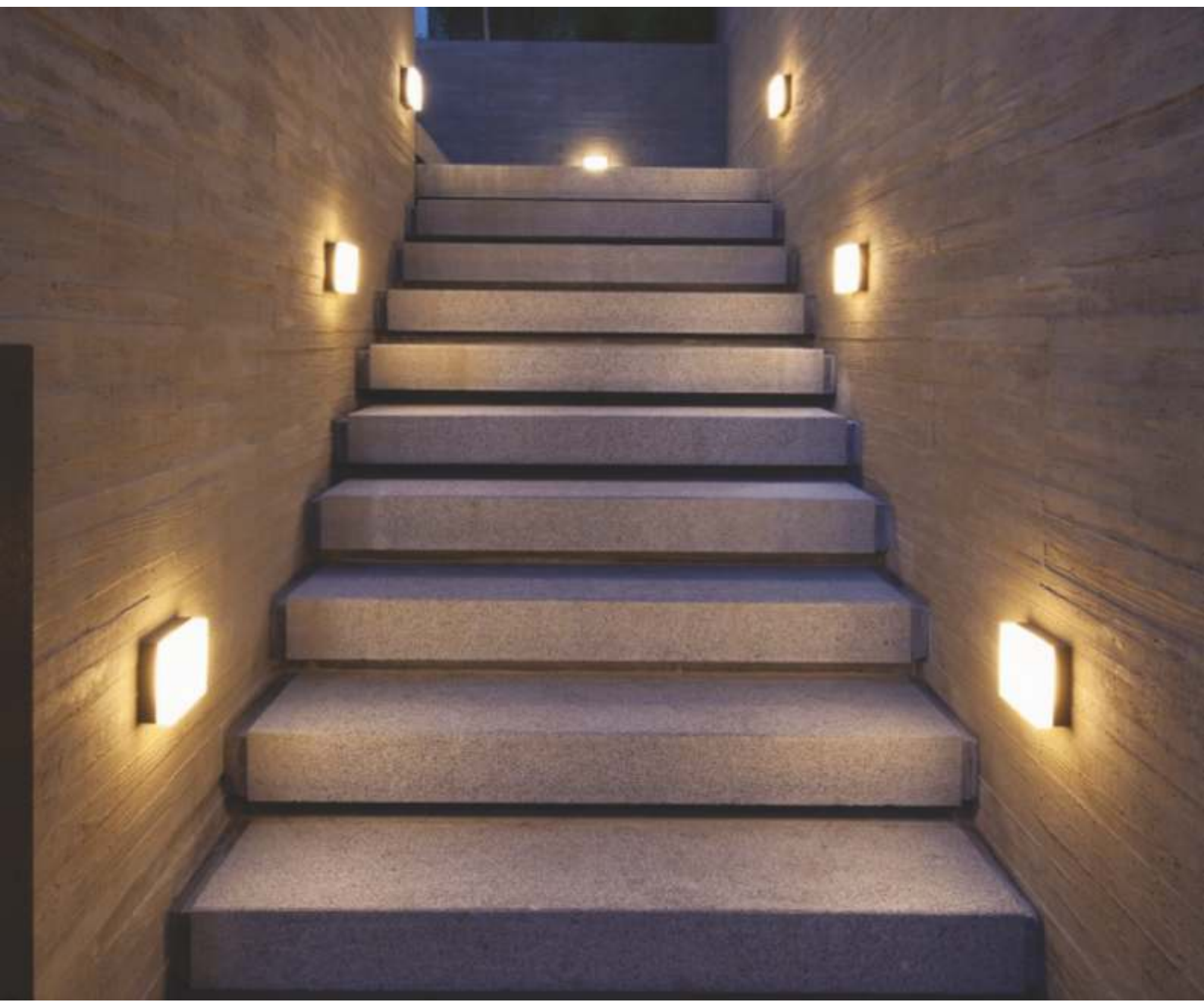

ALTIMA

Innovative Modular Design and Easy Installation





ALTIMA LED WALL LIGHT/ BULKHEAD

SMD	AC 85-265V	CCT WH/WW	FORM SQ	IP65	120°	Ra 75	2 YEAR GUARANTEE
-----	---------------	--------------	------------	------	------	-------	------------------

CODE	POWER	LUMENS	PF	DIMENSION	BOX QTY	PRICE
ST180	12W	960	>0.9	Ø190 x 100	20	744

*All sizes are in mm or inches

- 1 Bright, Soft & Uniform Light.
- 2 High Voltage Protection Till 380V
- 3 2.5 Kv Surge Protection
- 4 Water Resistance Body
- 5 Versatile Solution- Can Be Mounted On Ceiling & Wall



CRISA

AURA

NEST

LED BATTENS

SMD
AC 85-300V
120°
Ra 80
IP20
2 YEAR GUARANTEE

CRISA LED BATTEN

CODE	POWER	COLOR	LUMENS	PF	DIMENSION	BOX QTY.	PRICE
ST506	5W	WH/WW/NW	500	>0.9	300 X 37	50	269
ST507	10W	WH/WW/NW	1000	>0.9	600 X 37	50	310
ST501	22W	WH/WW/NW	2640	>0.9	1190 X 37	50	333

AURA LED BATTEN

CODE	POWER	COLOR	LUMENS	PF	DIMENSION	BOX QTY.	PRICE
ST509	18W	WH	1800	>0.9	1020 X 33	50	295

NEST LED BATTEN

CODE	POWER	COLOR	LUMENS	PF	DIMENSION	BOX QTY.	PRICE
ST530	20W	WW	2200	>0.9	Ø1190 X 37	50	320

* All sizes are in mm or inches

- 1 Slim Design With Decorative End Caps
- 2 Wide Voltage Range 100-300VAC
- 3 High Efficiency LED'S With 100 Lm/W
- 4 High Quality Light, CRI>80

LED BATTENS



SIRIUS



SONNET



VOLTAGE
FLUCTUATION
SHIELD

SMD
AC 85-300V
120°
Ra 80
IP20
2 YEAR GUARANTEE

NURO LED BATTEN

CODE	POWER	COLOR	LUMENS	PF	DIMENSION	BOX QTY.	PRICE
ST518	40W	WH	4400	>0.9	1200 X 37	25	900

SONNET LED BATTEN

CODE	POWER	COLOR	LUMENS	PF	DIMENSION	BOX QTY.	PRICE
ST508	45W	WH	4950	>0.9	1200 X 37	25	1090

* All sizes are in mm or inches

- 1 Non- Yellowing & High Efficiency Polycarbonate Diffuser
- 2 Wide Voltage Range 100-300VAC
- 3 High Efficiency LED'S With 100 Lm/W
- 4 Effective Heat Dissipation With Aluminum Extruded Heat Sink

EVO



EVO LED BATTEN

SMD	AC 85-300V	120°	Ra 80	IP20	2 YEAR GUARANTEE
-----	---------------	------	-------	------	------------------

CODE	POWER	COLOR	LUMENS	PF	DIMENSION	BOX QTY.	PRICE
ST510	22+2W	WH+WW WB+BL	2640	>0,9	1076 X 37	50	923

* All sizes are in mm or inches

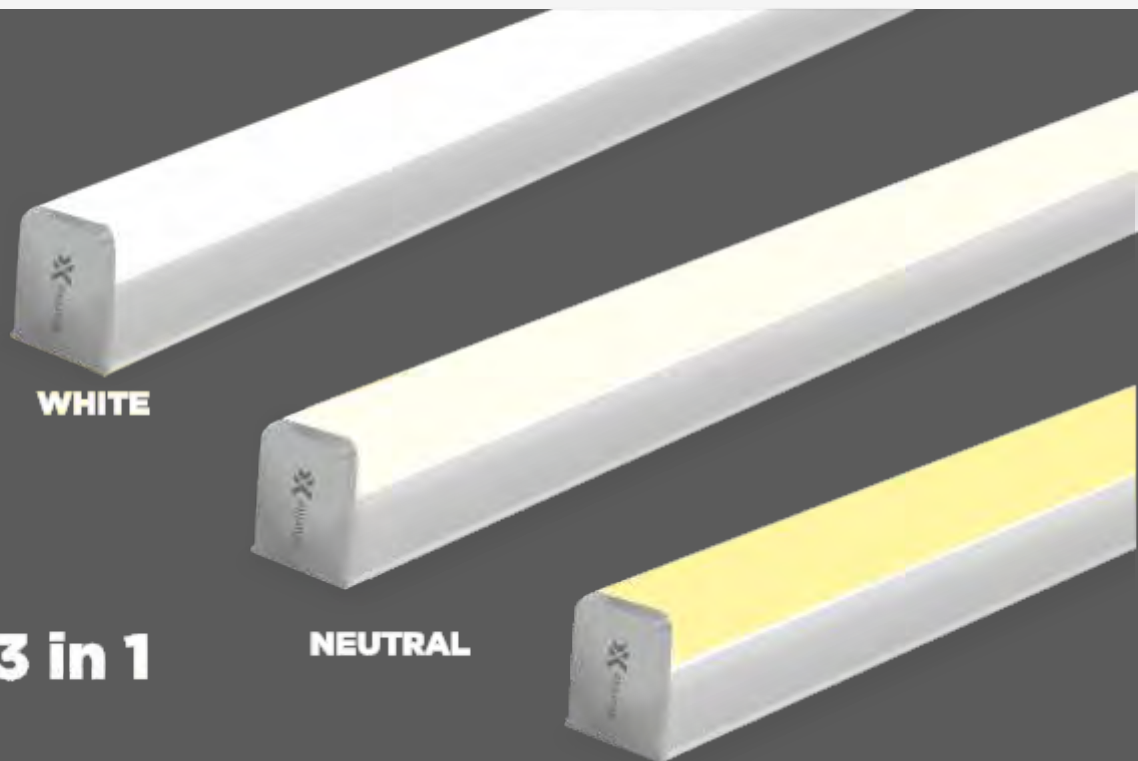

WHITE

NEUTRAL

WARM WHITE

CRISA 3 in 1

CRISA LED BATTEN

SMD	AC 85-300V	120°			
-----	---------------	------	--	--	--

CODE	POWER	COLOR	LUMENS	PF	DIMENSION	BOX QTY.	PRICE
ST501	22W	3CCT	2640	>0,9	1190 X 37	50	785

* All sizes are in mm or inches

INVERTER BULB

EMERGENCY LED BULB



INVERTER LED BULB

SMD	AC 85-270V	240°	Ra 80	IP20	B22 BASE	BATTERY 2600 MAH	2 YEAR GUARANTEE
-----	---------------	------	-------	------	----------	------------------	------------------

CODE	POWER	COLOR	LUMENS	PF	DIMENSION	BOX QTY.	PRICE
ST645	9W	WH	900	>0.9	Ø70 X 70 X 140	20	667

* All sizes are in mm or inches

- 1 High Power Backup
Up to 4 Hours
- 2 Powerful Lithium
battery - 2600 mAh
- 3 Long Battery Life
500+ charging Cycle
- 4 Durable Product
3.25kV Surge

BLOOM

FEEL GOOD | WORK BETTER



BLOOM LED HIGH WATTAGE BULB

SMD **AC 85-270V** **240°** **Ra 80** **IP20** **B22 BASE** **2 YEAR GUARANTEE**

CODE	POWER	COLOR	LUMENS	PF	DIMENSION	BOX QTY.	PRICE
ST631	30W	WH/WW	3000	>0.9	100 x 100 x 183	10	667
ST632	40W	WH/WW	4000	>0.9	120 x 120 x 226	10	924
ST633	50W	WH/WW	5000	>0.9	120 x 120 x 226	10	1090
ST634	60W	WH/WW	6000	>0.9	140 x 140 x 235	10	1500

* All sizes are in mm or inches

- 1 Wide Coverage With 240° Beam Angle
- 2 High Performance LED's With 100 Lm/W
- 3 2.5Kv Surge & 380VAC High Voltage Protection
- 4 Robust Design with Aluminium Die Cast Body

REVV

SEE THE RIGHT COLOR



REVV LED MIRROR LIGHT

SMD
AC 85-270V
120°
Ra 80
IP20
2 YEAR GUARANTEE

CODE	POWER	COLOR	LUMENS	PF	DIMENSION	BOX QTY.	PRICE
ST750	9W	WH/WW/NW	810	>0.6	Ø316 x 35 x 76	20	1307
ST750	9W	3 IN 1	810	>0.6	Ø316 x 35 x 76	20	1351
ST751	18W	WH/WW/NW	1620	>0.6	Ø632 x 35 x 76	20	1997
ST751	18W	3 IN 1	1620	>0.6	Ø632 x 35 x 76	20	2108

* All sizes are in mm or inches

- 1 Bright, Soft & Uniform Light
- 2 High Performance Led With 100 Lm/W
- 3 60X Better Than Traditional Fluorescent Tubes
- 4 Non- Yellowing & High Efficiency Polycarbonate Diffuser



Normal Light Spread

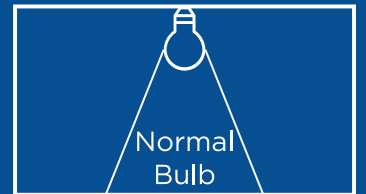

Wider Light Spread

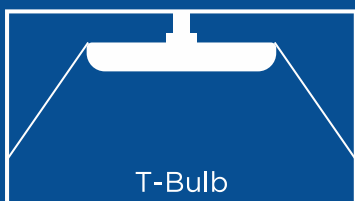

CONNECT T-BULB

THE RIGHT LIGHT FOR EVERY SPACE



Multi Angle Rotation

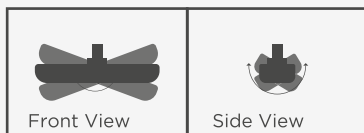

Wider Light Spread

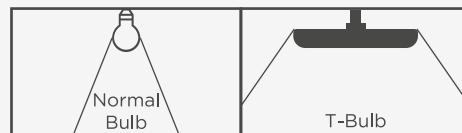

CONNECT LED T-BULB

SMD	AC 85-270V	120°	Ra 80	IP20	B22 BASE	2 YEAR GUARANTEE
-----	---------------	------	-------	------	----------	------------------

CODE	POWER	COLOR	LUMENS	PF	BOX QTY.	PRICE
ST520	10W	WH	1000	>0.9	60	269

* All sizes are in mm or inches

AIR MAX

ENHANCING RETAIL EXPERIENCE





AIR MAX LED TRACKLIGHT

COB
AC 85-270V
38°
Ra 80
IP20
BODY BLACK/WHITE
2 YEAR WARRANTY

CODE	POWER	LUMENS	PF	COLOR	DIMENSION	BOX QTY.	PRICE
ST315	20W	1800	>0.9	NW/WH/WW	Ø100 X 70	20	1536
ST316	30W	2700	>0.9	NW/WH/WW	Ø100 X 70	20	1760

* All sizes are in mm or inches

- 1 Great Rendering Of Colors & Whites & Excellent Color Consistency
- 2 High Luminous Flux At 90Lm/W
- 3 Attractive Design That Blends In With Store Architecture
- 4 Integrated Fan Design, Providing Consistent Cooling To The Module

VESTA

AN UNRIVALED COMBINATION OF LIGHT QUALITY AND EFFICIENCY



VESTA LED WALL LIGHT

COB	AC 85-270V	38°	CCT/NW WH/WW	BODY BLACK/WHITE	Ra 90	IP20	2 YEAR SERVICE WARRANTY
-----	---------------	-----	-----------------	---------------------	-------	------	----------------------------

CODE	POWER	LUMENS	PF	DIMENSION	BOX QTY.	PRICE
ST331	3W	240	>0.9	Ø83 X 60 X 110	40	647
ST332	6W	480	>0.9	Ø98 X 60 X 120	40	893
ST333	9W	810	>0.9	Ø106 X 60 X 130	20	1078
ST334	16W	1600	>0.9	Ø102 X 75 X 252	10	1709
ST335	30W	3000	>0.9	Ø140 X 118 X 282	10	2740
ST336	50W	5000	>0.9	Ø160 X 118 X 310	10	3834

* All sizes are in mm or inches

With
CITIZEN
LED

- 1 Superior Light Quality: Great Rendering Of Colors And Whites
- 2 High Luminous Flux At 100Lm/W
- 3 Attractive Design That Blends In With Store Architecture
- 4 High Color Rendering: CRI 90+



VESTA LED TRACK LIGHT

COB	AC 85-270V	38°	CCT/NW WH/WW	BODY BLACK/WHITE	Ra 90	IP20	2 YEAR SERVICE WARRANTY
-----	------------	-----	--------------	------------------	-------	------	-------------------------

CODE	POWER	LUMENS	PF	DIMENSION	BOX QTY.	PRICE
ST325	9W	810	>0.9	Ø141 X 58 X 140	20	1078
ST326	16W	1600	>0.9	Ø181 X 77 X 280	10	1709
ST327	30W	3000	>0.9	Ø198 X 100 X 300	10	2740
ST328	50W	5000	>0.9	Ø198 X 118 X 323	10	3834

* All sizes are in mm or inches

VESTA LED TRACK RAIL

BODY BLACK/WHITE	IP20	1 YEAR SERVICE WARRANTY
------------------	------	-------------------------

CODE	LENGTH	COLOR	BOX QTY.	PRICE
ST339	1M	WH/BLK	30	354
ST340	2M	WH/BLK	30	692

With
CITIZEN
LED

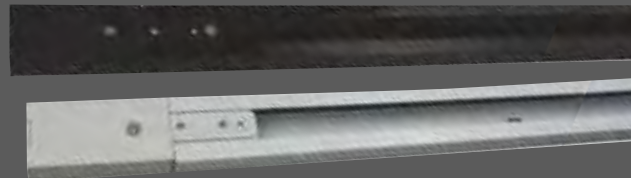

- 1 Superior Light Quality: Great Rendering Of Colors And Whites
- 2 High Luminous Flux At 100Lm/W
- 3 Attractive Design That Blends In With Store Architecture
- 4 High Color Rendering: CRI 90+

Ideal mix of outstanding light quality & energy savings for retailers

Store designers want a spot that fits in with their store design. Visual merchandisers need the very best light quality & spots that are easily adjustable. It gives visual merchandisers great rendering of 'colors & whites' & excellent color consistency, as well as well-defined, clean beams for Maximum Impact



BENEFITS

Clean & Robust
Design

Energy efficient &
low-maintenance

High-quality
accent lighting

Short payback compared
to conventional luminaries





AXON

UNIQUE DESIGN, UNIQUELY INSPIRING





AXON LED SPOTLIGHT

COB
AC 85-270V
CCT WH/WW
FORM RD
Ra 80
IP20
2 YEAR GUARANTEE

CODE	POWER	LUMENS	PF	BEAM	CUT OUT	DIMENSION	BOX QTY.	PRICE
ST625	6W	540	>0.6	35°	Ø70 or 2.75"	Ø80 X 70 X 35	50	430
ST626	9W	810	>0.6	45°	Ø85 or 3.35"	Ø100 X 85 X 37	50	569
ST627	12W	1080	>0.6	60°	Ø115 or 4.53"	Ø130 X 155 X 45	50	755

* All sizes are in mm or inches

- 1 Clear And Well Defined Beams
- 2 Wide Voltage Range & Surge Protection
- 3 Metal Sink Back For Good Heat Dissipation
- 4 Long Life Cob LED'S



S-AXIS

STRIKING DESIGN, GRACEFUL VERSATILITY



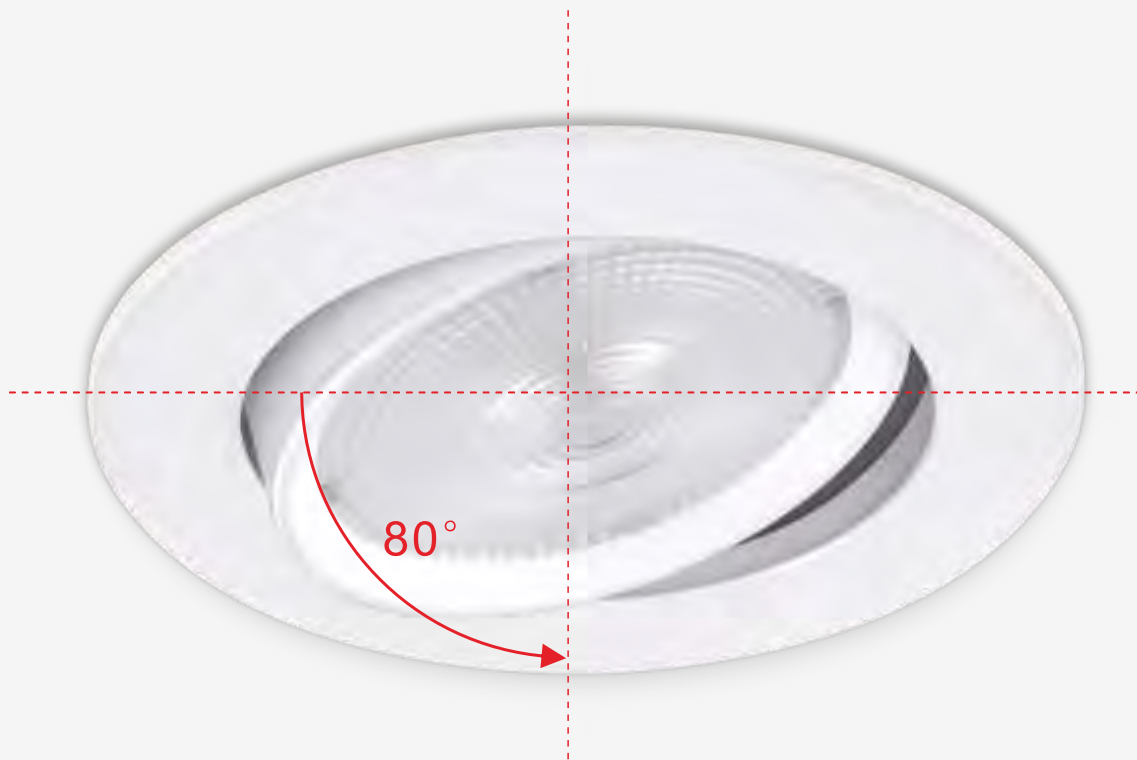

S-AXIS LED SPOT LIGHT

COB
AC 85-265V
CCT WH/WW
FORM RD
30°
Ra 85
IP20
2 YEAR GUARANTEE

CODE	POWER	LUMENS	PF	CUT OUT	DIMENSION	BOX QTY.	PRICE
ST290	3W	285	>0.6	Ø40 or 1.6"	Ø54X18	100	448
ST295	6W	570	>0.9	Ø55 or 2.5"	Ø75 x 36	40	727
ST291	10W	950	>0.9	Ø75 or 3"	Ø96X36	40	895
ST292	15W	1425	>0.9	Ø115 or 4.5"	Ø140X36	40	1355
ST293	20W	1900	>0.9	Ø145 or 6.7"	Ø170X36	20	1910
ST294	30W	2850	>0.9	Ø195 or 8.85"	Ø225X42	20	3239

* All sizes are in mm or inches



True Colour

With
CITIZEN
LED

- 1 High Quality Aviation Grade Aluminium
- 2 High performance LED chip
- 3 Upto 2.5KV Surge Protection
- 4 Clean & well defined beams
- 5 Excellent colour consistency

STRAVA

MAKE YOUR SPACE STAND OUT





STRAVA LED SURFACE SPOT LIGHT

COB
AC 85-265V
CCT WH/WW
FORM SQ
30°
Ra 85
IP20
2 YEAR GUARANTEE

CODE	POWER	LUMENS	PF	DIMENSION	BOX QTY.	PRICE
ST620	10W	950	>0.9	Ø70X19	40	746
ST621	15W	1425	>0.9	Ø111X22	40	1129
ST622	20W	1900	>0.9	Ø142X26	20	1529

* All sizes are in mm or inches



True Colour

With
CITIZEN
LED

- 1 High Quality Aviation Grade Aluminium
- 2 High performance LED chip
- 3 Upto 2.5KV Surge Protection
- 4 Clean & well defined beams
- 5 Excellent colour consistency



PRIUS

ENERGY EFFICIENT LED DOWNLIGHT





PRIUS LED SPOTLIGHT

COB	AC 85-270V	CCT WH/WW	FORM RD	Ra 80	IP20	2 YEAR GUARANTEE
------------	-----------------------	----------------------	--------------------	--------------	-------------	-------------------------

CODE	POWER	LUMENS	PF	BEAM	CUT OUT	DIMENSION	BOX QTY.	PRICE
ST621	3W	270	>0.6	35°	Ø67 or 1.8"	Ø67 X 45 X 32	100	242
ST622	7W	630	>0.6	45°	Ø55 or 3"	Ø105 X 75 X 51	50	437

* All sizes are in mm or inches

- 1 Clear And Well Defined Beams
- 2 Wide Voltage Range & Surge Protection
- 3 Metal Sink Back For Good Heat Dissipation
- 4 Long Life Cob LED'S



RAYSTAR

ENHANCE YOUR HOME, ENHANCE YOUR STYLE

RAYSTAR LED ROPE LIGHT-SMD 5050-60 LED-8MM

CODE	LED'S	COLOR	PF	LENGTH(MTR.)	WATT/MTR	PRICE
ST465	60	RGB	>0.9	90	9	11280
ST494	CONNECTOR WITHOUT REMOTE	-	-	-	-	230
ST495	CONNECTOR WITH REMOTE	-	-	-	-	339



RAYSTAR LED ROPE LIGHT-SMD 5730-120 LED-10MM

CODE	LED'S	COLOR	PF	LENGTH(MTR.)	WATT/MTR	PRICE
ST460	120	WH/WW/BL	>0.9	85	6	8945
ST461	120	RD/GN	>0.9	85	6	9375
ST462	120	PK	>0.9	85	6	9870
ST493	CHORD / CONNECTOR	-	-	-	-	77

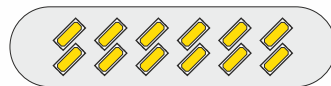

RAYSTAR LED ROPE LIGHT-SMD 5730-72 LED-8MM

CODE	LED'S	COLOR	PF	LENGTH(MTR.)	WATT/MTR	PRICE
ST471	72	WH/WW/BL	>0.9	80	5	6720
ST472	72	RD/GN	>0.9	80	5	7485
ST473	72	PK	>0.9	80	5	7765

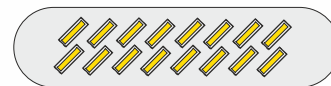

RAYSTAR LED ROPE LIGHT-SMD 3014-100 LED-4MM

CODE	LED'S	COLOR	PF	LENGTH(MTR.)	WATT/MTR	PRICE
ST451	100	WH/WW/BL	>0.9	85	4	5695
ST452	100	RD/GN	>0.9	85	4	6125
ST453	100	PK	>0.9	85	4	6650
ST491	CORD / CONNECTOR	-	-	-	-	41





EXPERIENCE
new Lighting

RAYSTAR

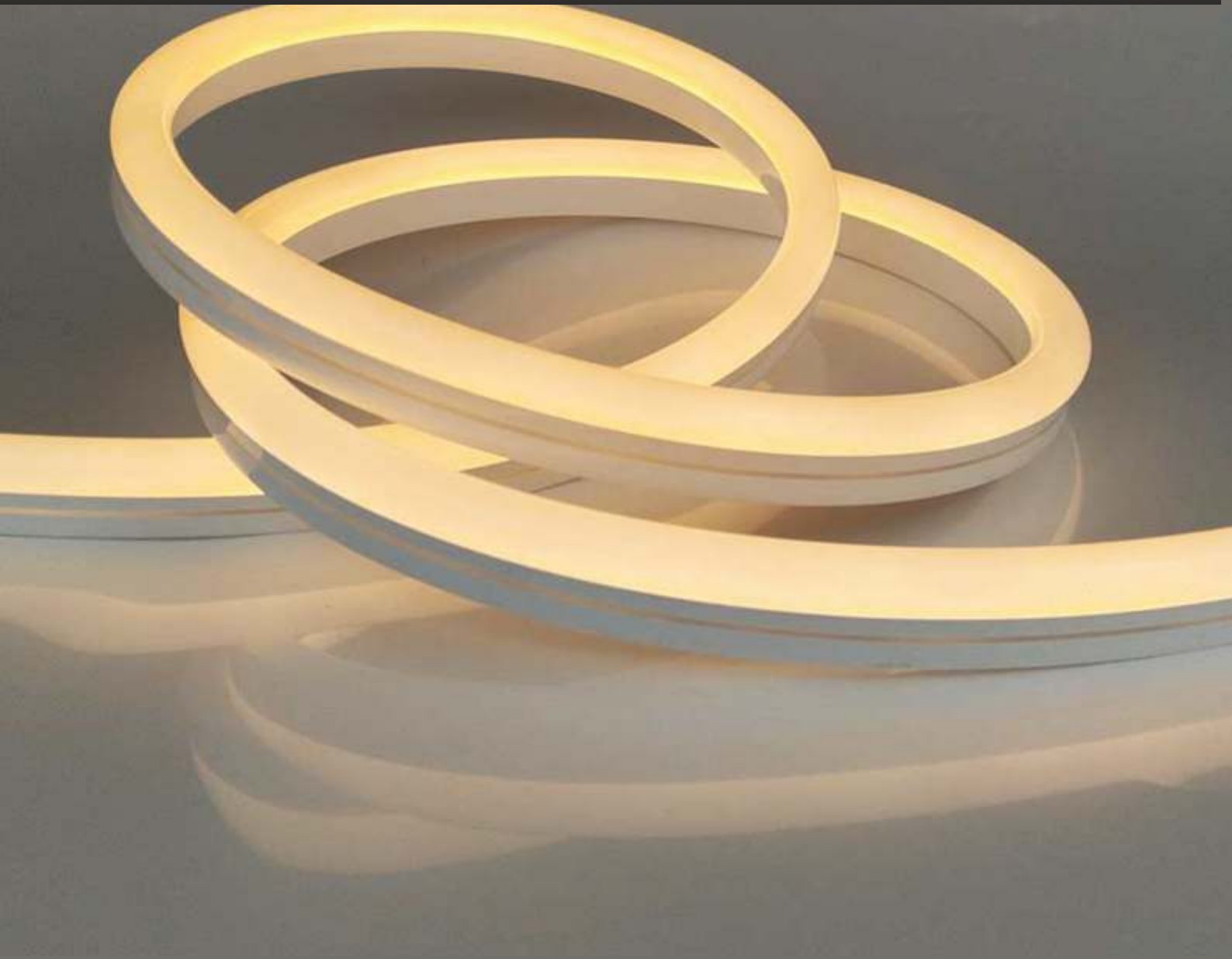

RAYSTAR 2835-100 LED NEON ROPELIGHT

SMD	IP65	INPUT VOLT 12V	LENGTH IN MTR 45	COLORS WH/WW/RD/BL/GN PK/AMBER/ICE BLUE
------------	-------------	---------------------------	-----------------------------	--

CODE	LED'S	PF	WATT/MTR	PRICE
ST478	60	>0.9	7.5W	10385
ST479	2385-100	-	8MM	77

- 1 100 LED's Per Meter
- 2 Clear Silicone
- 3 Double PCB
- 4 25 LM Per LED

HELIX

BRING LIFE TO YOUR SPACE



HELIX 5050-60 LED ROPE LIGHT

SMD	IP65	INPUT VOLT 12V	LENGTH IN MTR 100	1 YEAR GUARANTEE
-----	------	-------------------	----------------------	------------------

CODE	LED'S	COLOR	PF	LENGTH(MTR.)	WATT/MTR	PRICE
ST467	60	WH/WW/BL	>0.9	100	12W	23100
ST468	CORD / CONNECTOR	-	-	-	-	243

Yellowing Resistance

Sturllite silicone coating



Other thermal coating



Excellent Stability



UV

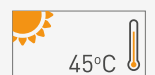

45°C

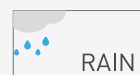

RAIN



-20°C

- 1 60 LED's Per Meter
- 2 3 Chip
- 3 Double PCB
- 4 14 Lumens Per Led

PYXIS

HIGH PERFORMANCE LIGHTING



Yellowing Resistance

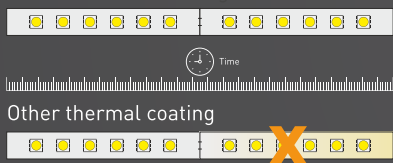

Excellent Stability

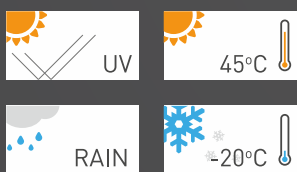

PYXIS 3030-96 LED ROPE LIGHT

SMD
IP65
INPUT VOLT 12V
LENGTH IN MTR 90
1 YEAR GUARANTEE

CODE	LED'S	COLOR	PF	LENGTH(MTR.)	WATT/MTR	PRICE
ST480	96	WH/WW/NW	>0.9	90	8.5	29621
ST481	LED-ROPELIGHT-SMD 3030 LED-10MM	CORD	-	-	-	1065

- 1 96 LED's Per Meter
- 2 Clear Silicone
- 3 Double PCB
- 4 45 Lumens Per Led

TWNK

ENRICH YOUR AMBIENCE



TWNK s5050-60 LED STRIP LIGHT

SMD
IP20
INPUT VOLT 12V
LENGTH IN MTR 5
Ra 90
20 LUMENS/LED
120°
1 YEAR GUARANTEE

CODE	WATT 5 MTR	COLOR	PF	BOX QTY.	PRICE
ST401	60W	WH/WW/BL	>0.9	40	617
ST402	60W	RD/GN	>0.9	40	661
ST403	60W	PK/AMBER	>0.9	40	720
ST404	60W	RGB	>0.9	40	862

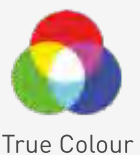

- 1 Exceptionally Low Power Consumption
- 2 Flexible & Easy Installation With Heat Sink Tape
- 3 20 Lumens Per LED
- 4 Fluctuation Proof
- 5 High Color Rendering With CRI>90

TWINK 2835-120 LED STRIP LIGHT

SMD
IP20
INPUT VOLT 12V
LENGTH IN MTR 5
Ra 90
24 LUMENS/LED
120°
1 YEAR GUARANTEE

CODE	WATT 5 MTR	COLOR	PF	BOX QTY.	PRICE
ST410	60W	WH/WW/BL	>0.9	40	924



TWINK 2835-204 LED STRIP LIGHT

SMD
IP20
INPUT VOLT 12V
LENGTH IN MTR 5
Ra 90
24 LUMENS/LED
120°
1 YEAR GUARANTEE

CODE	WATT 5 MTR	COLOR	PF	BOX QTY.	PRICE
ST411	80W	WH/WW/BL	>0.9	40	1386



TWINK 2835-240 LED STRIP LIGHT

SMD
IP20
INPUT VOLT 12V
LENGTH IN MTR 5
Ra 90
24 LUMENS/LED
120°
1 YEAR GUARANTEE

CODE	WATT 5 MTR	COLOR	PF	BOX QTY.	PRICE
ST416	90W	WH/WW/NW	>0.9	40	1540



Bring Life to your Space

Sturlite's LED strip lighting fixtures add an attractive appearance & provide dependable performance for office, commercial & retail lighting applications. Reliable strip lighting systems from Sturlite help to improve safety & increase energy savings, while enhancing productivity & efficiency.

BENEFITS

High Luminous Flux

High CRI >90

Exceptionally low power Consumption



SPARC

BEAUTIFYING YOUR WORLD



True Colour

SPARC s5050-60 LED STRIP LIGHT

SMD	IP20	INPUT VOLT 12V	LENGTH IN MTR 5	Ra 90	18 LUMENS/LED	120°	1 YEAR GUARANTEE
-----	------	-------------------	--------------------	-------	------------------	------	------------------

CODE	WATT 5 MTR	COLOR	PF	BOX QTY.	PRICE
ST405	60W	WH/WW/BL/NW	>0.9	100	416
ST406	60W	RD/GN/PK/ AMBER/VIOLET	>0.9	100	456

- 1 Exceptionally Low Power Consumption
- 2 Flexible & Easy Installation With 3M Tape
- 3 18 Lumens Per LED
- 4 Fluctuation Proof
- 5 High Color Rendering With CRI>90

UNIVERSAL DRIVER



BASIC

LED STRIP DRIVER

1 YEAR GUARANTEE

CODE	POWER	WATT 5 MTR	INPUT VOLT	BOX QTY.	PRICE
ST421	2AMPS	12V-24W	AC85-265V	100	208
ST422	5AMPS	12V-60W	AC85-265V	100	456
ST423	10AMPS	12V-120W	AC85-265V	50	808
ST424	15AMPS	12V-180W	AC85-265V	30	1390
ST431	RGB REMOTE	12V-60W	AC85-265V	100	190
ST432	RGB DRIVER	12V-60W	AC85-265V	100	153

PRIME

LED UNIVERSAL DRIVERS SMPS

1 YEAR GUARANTEE

CODE	POWER	WATT 5 MTR	INPUT VOLT	BOX QTY.	PRICE
ST434	2AMPS (SMPS)	12V-24W	AC85-265V	100	454
ST435	3AMPS (SMPS)	12V-36W	AC85-265V	100	515
ST436	5AMPS (SMPS)	12V-60W	AC85-265V	100	679
ST437	10AMPS (SMPS)	12V-120W	AC85-265V	50	946
ST438	12.5AMPS (SMPS)	12V-150W	AC85-265V	50	1313
ST439	16.5AMPS (SMPS)	12V-200W	AC85-265V	30	1510
ST440	25AMPS (SMPS)	12V-300W	AC85-265V	30	1887
ST441	33.5AMPS (SMPS)	12V-400W	AC85-265V	30	2415

STADIA

FOR EVERY PROJECT WHERE LIGHT REALLY MATTERS

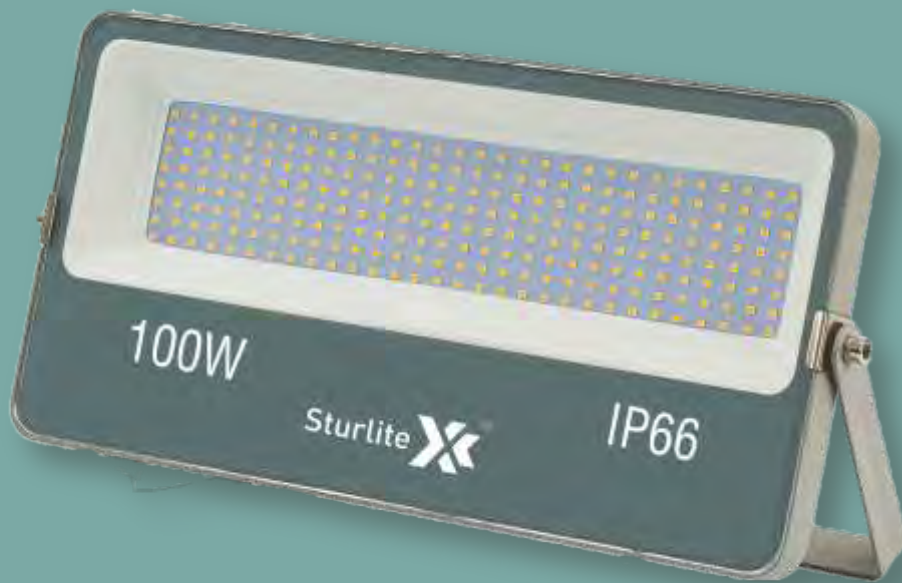

STADIA LED FLOOD LIGHT

SMD
AC 85-440V
CCT WH
120°
Ra 80
IP66
2 YEAR GUARANTEE

CODE	POWER	LUMENS	PF	DIMENSION	BOX QTY.	PRICE
ST831	50W	5500	>0.9	Ø270 X 127	10	1916
ST832	100W	11000	>0.9	Ø350 X 170	10	3249
ST833	150W	16500	>0.9	Ø380 X 180	5	5259

* All sizes are in mm or inches

1 Highly Efficient:
Up To 110 Lm/W

2 Wide Voltage
Range Ac85-440V

3 High Surge
Protection:6 Kv

4 Robust, High-
Quality Finish

5 Pressure Die Cast Housing For Good Heat
Dissipation And Increase Of Service Life

SPEKTR

DURABLE & ROBUST
IDEAL FOR ENVIRONMENTALLY DEMANDING LOCATIONS





SPEKTR LED FLOOD LIGHT

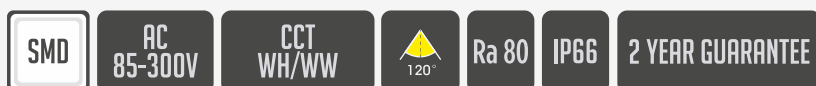

CODE	POWER	LUMENS	PF	DIMENSION	BOX QTY.	PRICE
ST361	10W	1000	>0.9	Ø126 X 118 X 38	50	1021
ST362	20W	2000	>0.9	Ø192 X 72 X 194	20	1372
ST363	30W	3000	>0.9	Ø235 X 62 X 245	20	1877
ST364	50W	5000	>0.9	Ø270 X 281 X 65	5	2383
ST365	100W	10000	>0.9	Ø300 X 281 X 75	5	3629
ST366	150W	15000	>0.9	Ø287 X 287 X 84	5	5872
ST367	200W	20000	>0.9	Ø362 X 333 X 85	5	7154
ST368	300W	30000	>0.9	Ø423 X 384 X 87	1	14616
ST369	400W	40000	>0.9	Ø423 X 384 X 87	1	16462
ST700	500W	50000	>0.9	Ø510 X 510 X 111	1	30154

* All sizes are in mm or inches

- 1 Highly Efficient: Up To 100 Lm/W
- 2 Up To 6Kv/8Kv Surge Protection
- 3 Over Voltage Protection & Under Voltage Protection
- 4 Pressure Die Cast Housing For Good Heat Dissipation And Increase Of Service Life



Sturlite LED Floodlights are a general purpose LED flood lighting luminaire for various lighting applications, such as area lighting, bill-board, façade, industry area and other general applications. Sturlite LED Floodlights takes advantage of LED technology which provides energy savings and a longer lifetime, bringing area lighting into a new era.

BENEFITS

Robust, High-quality Finish

High Surge Protection

High System Flux

Pressure die cast body



For every Project
where **Light** really
Matters

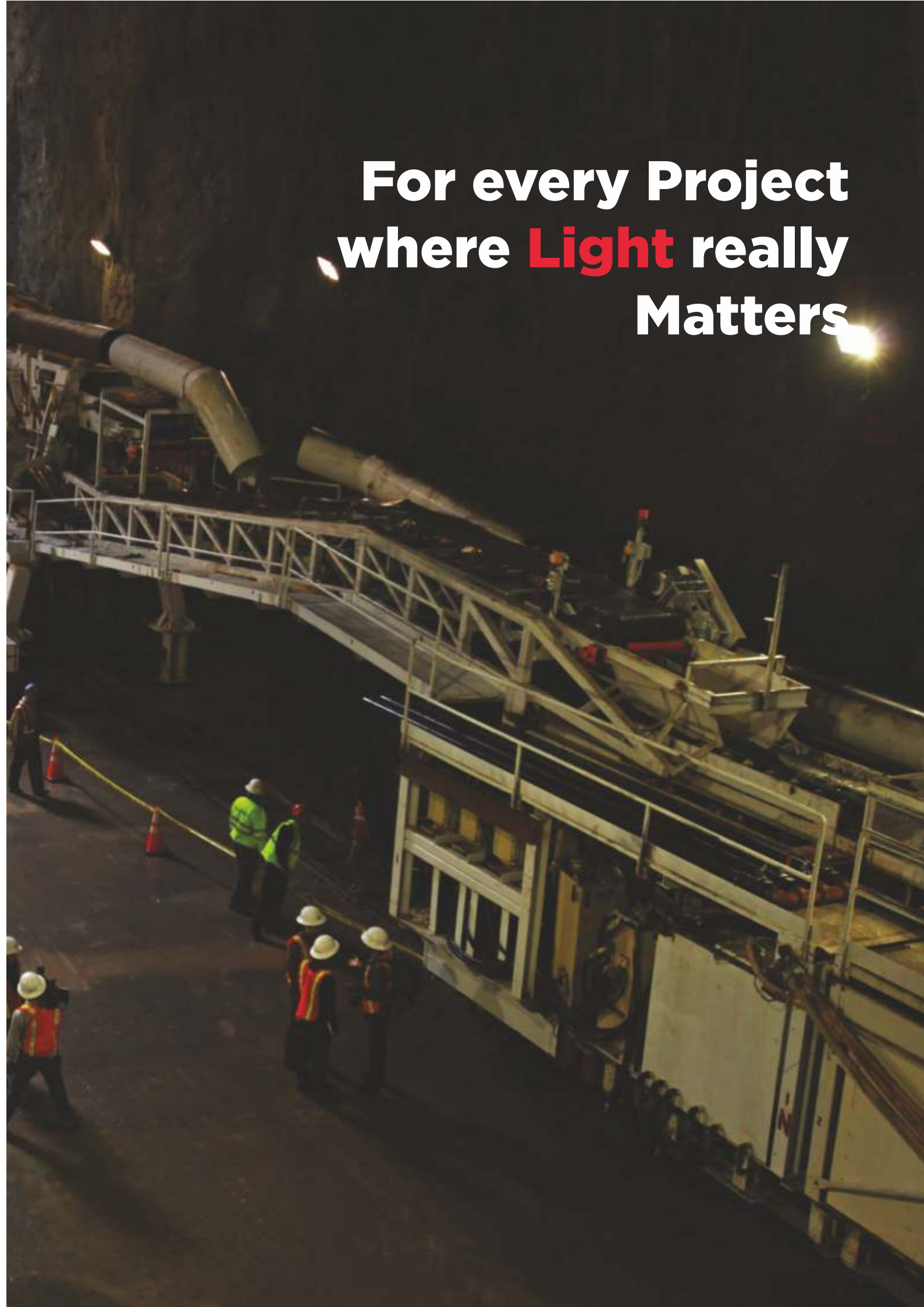

AVIOR

A FLOOD LIGHTING SOLUTION WITH PRECISE OPTICAL CONTROL



AVIOR LED FLOODLIGHT

SMD
AC 85-440V
CCT WH
75°
Ra 80
IP66
2 YEAR GUARANTEE

CODE	POWER	LUMENS	PF	DIMENSION	BOX QTY.	PRICE
ST820	50W	5500	>0.9	Ø240 X 160 X 26	10	1923
ST818	100W	11000	>0.9	Ø300 X 200 X 35	10	3077
ST819	150W	16500	>0.9	Ø360 X 240 X 35	5	4872

* All sizes are in mm or inches

1 Highly Efficient:
Up To 110 Lm/W

2 High Surge
Protection : 6 Kv

3 High-Performance Asymmetrical
& Symmetrical Optics

4 Pressure Die Cast Housing For Good Heat
Dissipation & Increase Of Service Life

5 Anti Dust/
Anti Fog System

METEOR

COST EFFICIENT & HIGH PERFORMANCE LED STREET LIGHT



METEOR LED STREET LIGHT

SMD
AC 85-300V
CCT WH
120°
Ra 80
IP66
2 YEAR GUARANTEE

CODE	POWER	LUMENS	PF	DIMENSION	BOX QTY.	PRICE
ST371	18W	2340	>0.9	Ø120 X 120 X 40	30	1173
ST372	32W	4160	>0.9	Ø183 X 182 X 48	20	1935
ST373	50W	6500	>0.9	Ø226 X 220 X 53	12	2916
ST374	100W	13000	>0.9	Ø285 X 273 X 60	10	6672

* All sizes are in mm or inches

- 1 Up To 130Lm/W Luminous Efficacy
- 2 Up To 6Kv Surge Protection
- 3 Corosion Resistant Coating
- 4 Pressure Die Cast Housing For Good Heat Dissipation & Increase Of Service Life
- 5 Highly-Integrated Components & Housing For Slim Size

ASTEOR

BUILD TO LAST. DESIGNED TO SAVE



ASTEOR LED STREET LIGHT



CODE	POWER	LUMENS	PF	DIMENSION	BOX QTY.	PRICE
ST376	20W	2400	>0.9	Ø310 X 109 X 51	20	1360
ST377	30W	3600	>0.9	Ø340 X 124 X 47	20	1521
ST378	50W	6000	>0.9	Ø391 X 145 X 56	20	2052
ST379	100W	12000	>0.9	Ø470 X 170 X 56	10	3995

* All sizes are in mm or inches

- 1 Up To 120Lm/W Luminous Efficacy
- 2 Up To 6Kv Surge Protection
- 3 Corosion Resistant Coating
- 4 Pressure Die Cast Housing For Good Heat Dissipation & Increase Of Service Life
- 5 Highly-Integrated Components & Housing For Slim Size

DYNAMIQ

ROBUST DESIGN, SUPERIOR PERFORMANCE



DYNAMIQ LED STREET LIGHT

SMD
AC 85-265V
CCT WH
120°
Ra 80
IP66
2 YEAR GUARANTEE

CODE	POWER	LUMENS	PF	DIMENSION	BOX QTY.	PRICE
ST870	18W	2160	>0.9	Ø269 X 80 X 40	20	928
ST871	24W	2880	>0.9	Ø323 X 110 X 60	20	1397
ST872	36W	4320	>0.9	Ø370 X 150 X 57	12	1748
ST873	50W	6000	>0.9	Ø373 X 160 X 60	12	2238
ST874	72W	8640	>0.9	Ø393 X 195 X 70	10	3236
ST875	100W	12000	>0.9	Ø393 X 195 X 70	10	4195
ST827	150W	15000	>0.9	Ø445 X 216 X 89	10	6966

* All sizes are in mm or inches

- 1 High Performance LED's with 120 Lm/w
- 2 Up to 6Kv Surge Protection
- 3 Corrosion Resistant Coating
- 4 Pressure Die Cast Housing for Good Heat Dissipation & Increase of Service Life

INFINY

ENERGY EFFICIENT LIGHTING FOR INDUSTRIAL & COMMERCIAL APPLICATIONS



INFINY LED HIGH-BAY LIGHT

SMD
AC 85-300V
CCT WH
120°
Ra 80
IP66
2 YEAR WARRANTY

CODE	POWER	LUMENS	PF	DIMENSION	BOX QTY.	PRICE
ST635	50W	6500	>0.9	179x93mm	1	4398
ST636	100W	13000	>0.9	395x165mm	1	9103
ST637	150W	19500	>0.9	395x165mm	1	10859
ST638	200W	26000	>0.9	404x175mm	1	15167

* All sizes are in mm or inches

- 1 High quality white light
- 2 Controlled light distribution
- 3 Corrosion Resistant Coating
- 4 Pressure Die Cast Housing For Good Heat Dissipation & Increase Of Service Life

Trusted Performance

EVERYDAY

Sturlite Highbay is a high efficient and reliable LED luminaire. Designed as the point to point replacement for HPI 250W/400W luminaires, it offers customers all the benefits of LED lighting - reduced energy consumption, longer service time and less maintenance.

BENEFITS

Reduced Energy
Consumption

Superior Light
Quality

Longer Service
Lifetime

Easy Installation
& Retrofitting

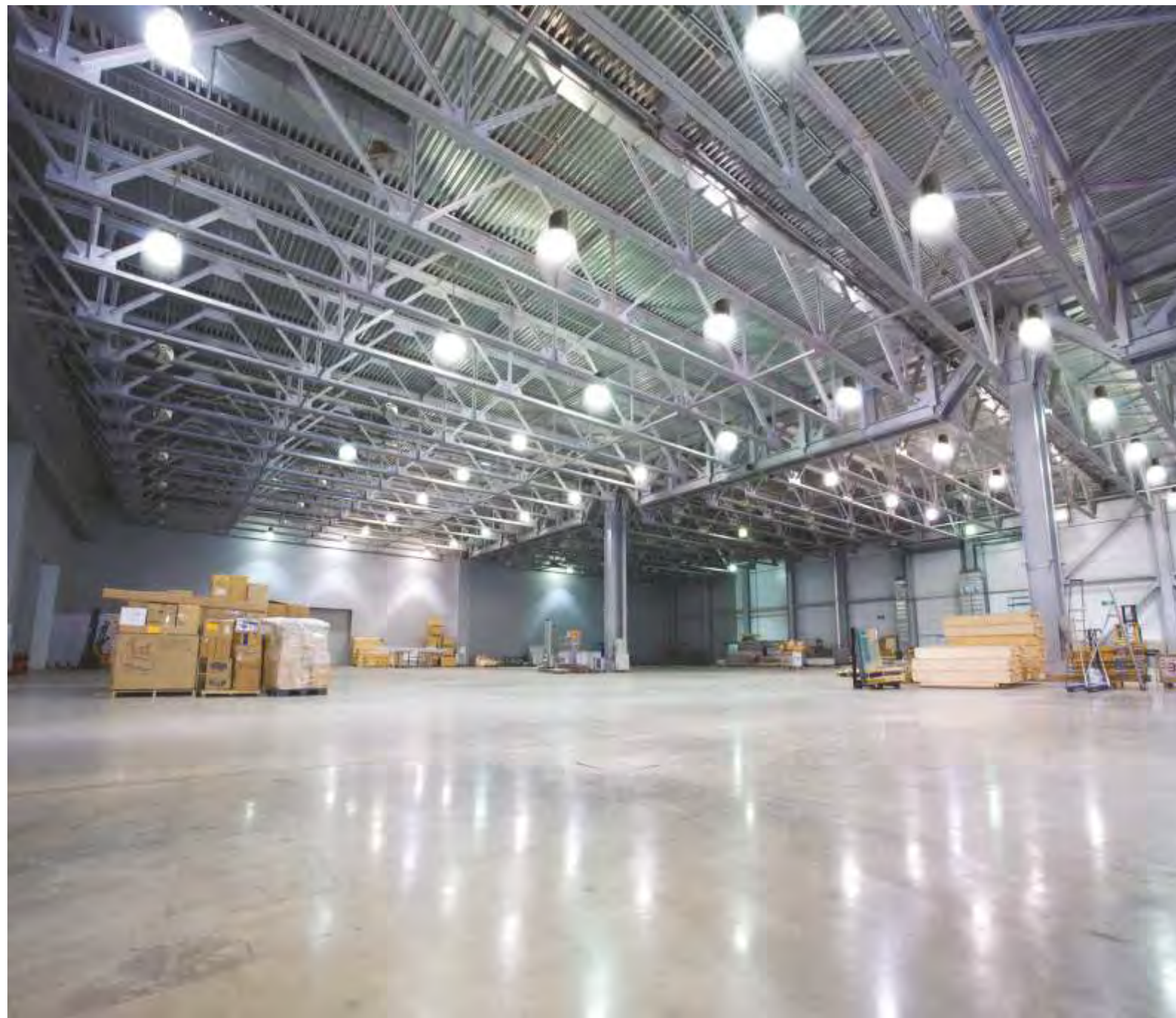

SF50 SERIES

A WHOLE LOT OF SCIENCE THAT DELIVERS QUALITY LIGHT



SF50 SERIES LED SOLAR FLOODLIGHT

SMD
SOLAR WITHOUT MOTION SENSOR
CCT WH
120°
Ra 70
IP67
2 YEAR WARRANTY

CODE	POWER	BATTERY	LUMENS	PF	DIMENSION	BOX QTY.	PRICE
ST771	60W	3.2V 12AH	5700	>0.9	167 X 226 X 35	10	5590
ST772	120W	3.2V 18AH	11400	>0.9	200 X 272 X 61	5	9821
ST775	ARM HANDLE	-	-	-	-	5	628

* All sizes are in mm or inches

1 Polycrystalline Solar Panel

2 Large Capacity Lithium Battery

3 High Photoelectric Conversion, Fast Charging

4 Multi-Functional Intelligent Remote Control

SX200 SERIES

BRINGING THE NIGHT SCENE TO LIFE



SX200 SERIES LED SOLAR STREETLIGHT

SMD
SOLAR WITHOUT MOTION SENSOR
CCT WH
120°
Ra 70
IP67
2 YEAR WARRANTY

CODE	POWER	BATTERY	LUMENS	PF	DIMENSION	BOX QTY.	PRICE
ST781	24W	3.2V 12AH	2280	>0.9	95 X 335 X 60	1	9252
ST782	50W	3.2V 18AH	4750	>0.9	130 X 385 X 65	1	12088

* All sizes are in mm or inches

1 Polycrystalline Solar Panel

2 Large Capacity Lithium Battery

3 High Photoelectric Conversion, Fast Charging

4 Multi-Functional Intelligent Remote Control

SX300 SERIES

A LUMINAIRE WITH VISUAL POWER



SX300 SERIES LED SOLAR STREETLIGHT

SMD
SOLAR WITH MOTION SENSOR
CCT WH
120°
Ra 70
IP67
2 YEAR WARRANTY

CODE	POWER	BATTERY	LUMENS	PF	DIMENSION	BOX QTY.	PRICE
ST785	20W	3.2V 6AH	1900	>0.9	210 X 400 X 60	10	3245
ST786	40W	3.2V 8AH	3800	>0.9	235 X 500 X 70	10	5310
ST787	60W	3.2V 12AH	5700	>0.9	266 X 630 X 70	5	7835

* All sizes are in mm or inches

- 1 Inbuilt Polycrystalline Solar Panel
- 2 High Grade ABS Housing
- 3 High Photoelectric Conversion, Fast Charging
- 4 With Inbuilt Motion Sensor For Auto On/Off

Bringing the Night Scene to Life

Integrated solar street light/External Solar street light with Lithium Ferro Phosphate battery, solar panel, charger and optional PIR sensor built into the luminaire. Pressure die cast aluminium for sturdiness and long life. Specially designed pole mounting bracket allows different tilt angles, lateral and pole top mounting.

BENEFITS

- Brings light to areas without access to electric grid
- Preserves landscape as no trenching for cabling required
- Sturdy construction for long life



EXPLORE OUR WIDE RANGE OF WIRES & CABLES

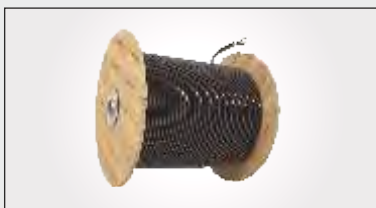

Multicore

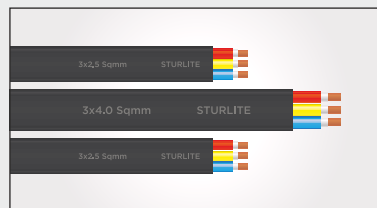

Submersible



UG Cables



SWITCHING TO LED HAS NEVER BEEN SIMPLER

The Sturlite Ledinaire range features a selection of popular LED luminaries that are energy efficient and reliable, at a price you can afford. We keep our prices competitive by focusing on those runner types that are most in demand, while keeping the packaging and service straightforward. Evidently you can be sure the product reliability achieves our high quality standards



Affordable Lighting
from the reputed
name in LED



Smart and
energy efficient



Quality you can trust
You get exactly you
see on the box



Using
BIS Approved
Control Gear

